

ALL SUB FRAMES WILL BE WELDED WITH MAINSTRUCTURE

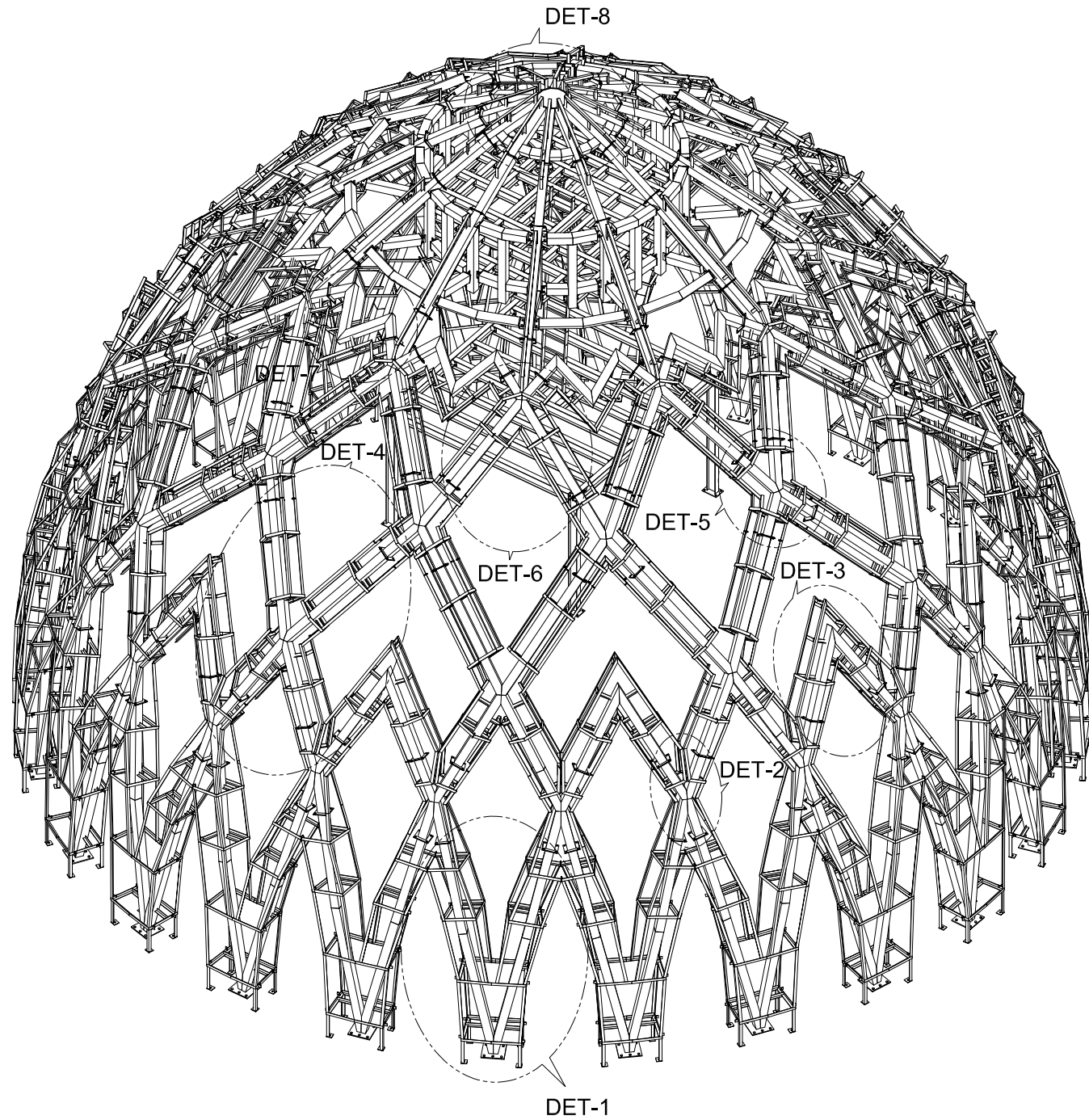

3D VIEW-WITH SUB FRAME

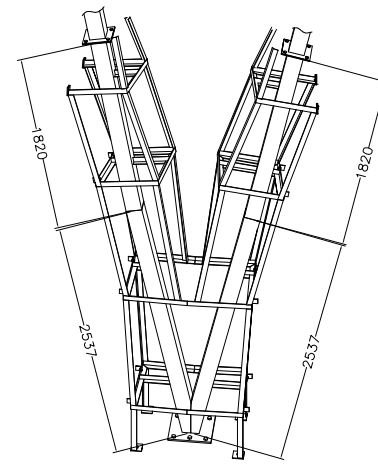

DETAIL-1

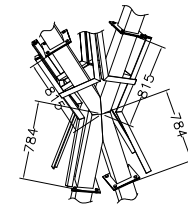

DETAIL-2

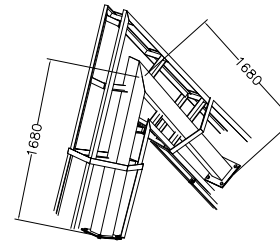

DETAIL-3

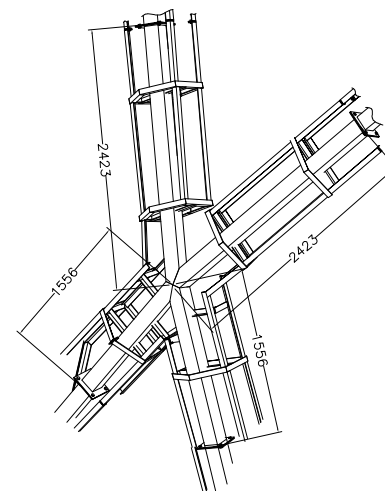

DETAIL-4

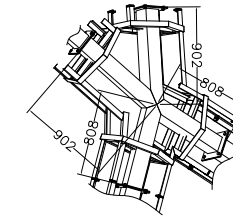

DETAIL-5

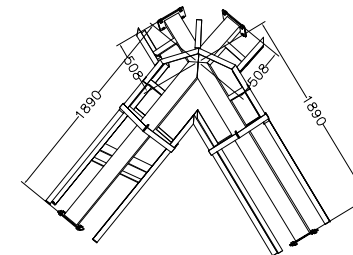

DETAIL-6

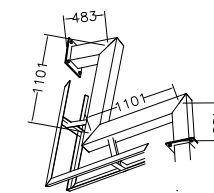

DETAIL-7

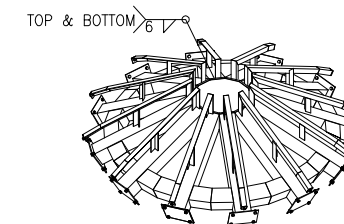

TOP & BOTTOM

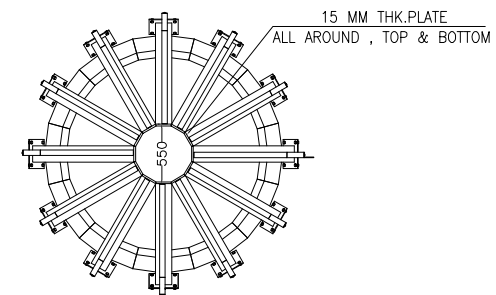

DETAIL-8

15 MM THK. PLATE
ALL AROUND, TOP & BOTTOM

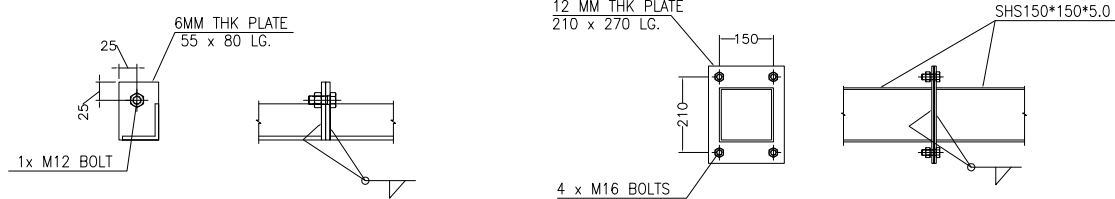

TYPICAL CONNECTION DETAILS